

Laje de fundo - Armação
escala 1:25

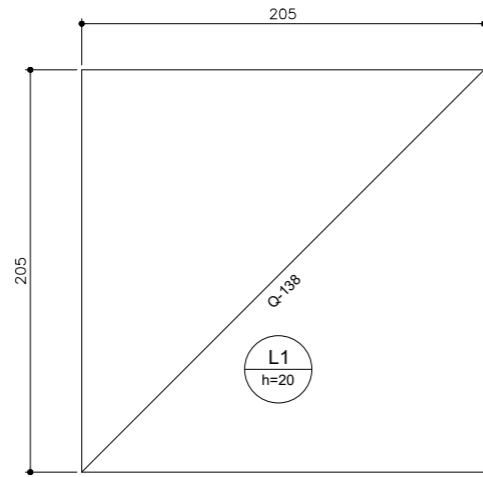

Laje de fundo - Armação
escala 1:25

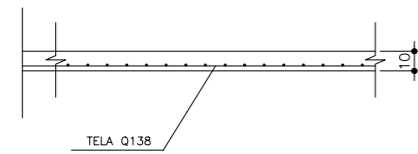

Laje de fundo - Corte
escala 1:25

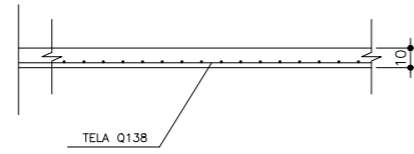

Laje de fundo - Corte
escala 1:25

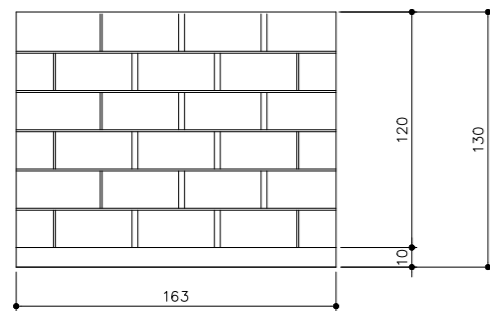

Corte
escala 1:25

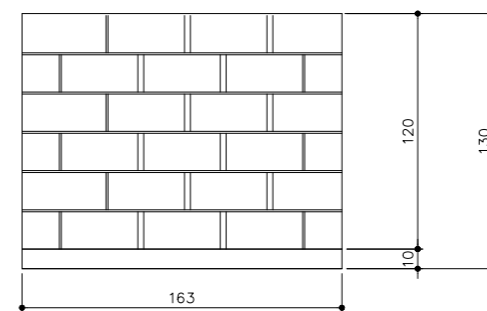
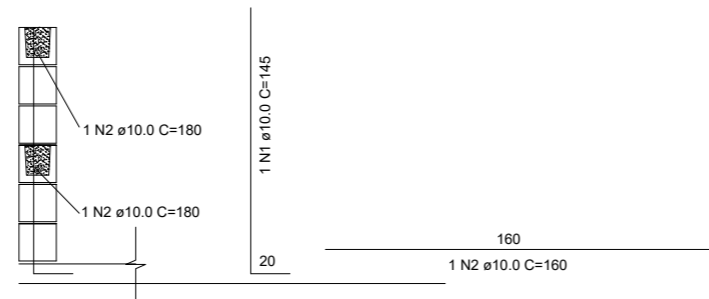

Corte
escala 1:25

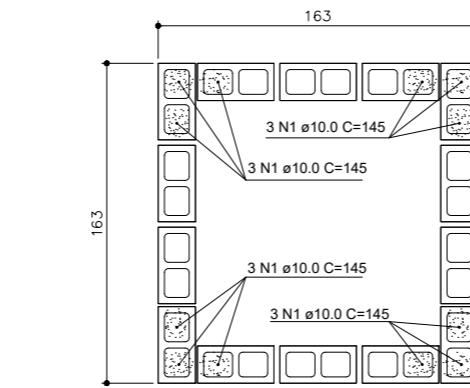
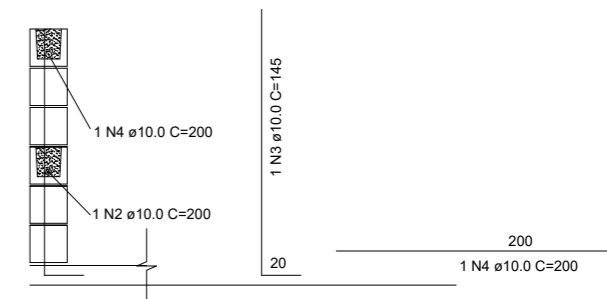

1ª Fiada
escala 1:25

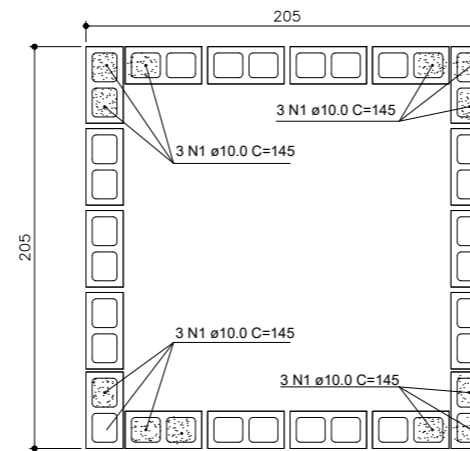

1ª Fiada
escala 1:25

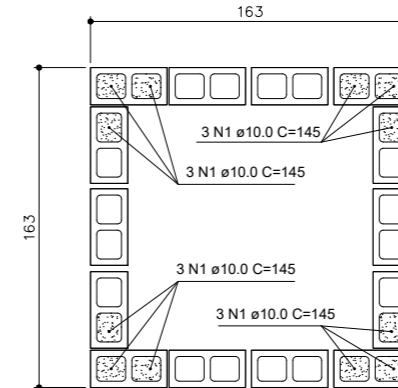

2ª Fiada
escala 1:25

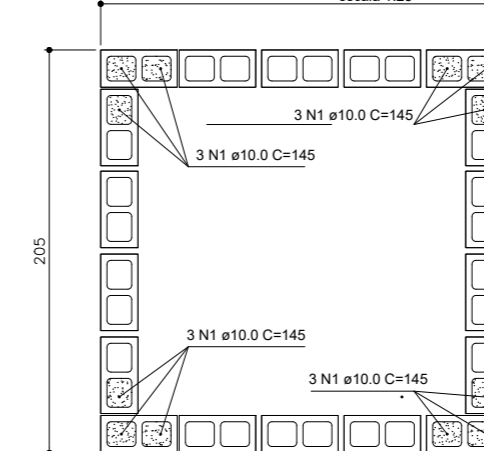

2ª Fiada
escala 1:25

RELAÇÃO DE AÇO CAIXA 1,20 X 1,20

AÇO	N	DIAM (mm)	QUANT	C. UNIT (cm)	C. TOTAL (cm)
CA50	1	10.0	12	145	1.740,0
	2	10.0	8	160	1.280,0

RESUMO DE AÇO

AÇO	DIAM (mm)	C. UNIT (m)	PESO (kg)
CA50	10.0	30,2	19,0

PESO TOTAL (KG)

CA50	19,0
CA60	0

RELAÇÃO DE AÇO CAIXA 1,60 X 1,60

AÇO	N	DIAM (mm)	QUANT	C. UNIT (cm)	C. TOTAL (cm)
CA50	1	10.0	12	145	1.740,0
	2	10.0	8	200	1.600,0

RESUMO DE AÇO

AÇO	DIAM (mm)	C. UNIT (m)	PESO (kg)
CA50	10.0	33,4	21,0

PESO TOTAL (KG)

CA50	21,0
CA60	0

RESUMO TELA Q-138

TIPO	QUANT. m2	Kg
Q-138	6,85	15,15
TOTAL		15,15